



QING

Intelligent Gimbal for Camera

Instructions

EN V1.0

Catalogue

1. Overview	2
2. Start to Use	4
2.1 Charging	4
2.2 Unlock/Lock	5
2.3 Battery Installation	5
2.4 Camera Installation and Balance	6
2.5 Power On/Off	8
3. Function & Operation	9
3.1 Function/Modes Introduction	9
3.2 Function Operation of Remote Control	12
3.3 Remote Control Touch Screen	16
3.4 Modes Setting	17
3.5 Gimbal Initialization	21
4. Accessories	22
4.1 Brushless Follow Focus (AKF II)	22
4.2 Wireless MIC Kit	23
5. Specifications	25
Compatible Cameras for Reference	26
Disclaimer	28

QING is a professional gimbal for DSLR/mirrorless camera. It is compatible with popular DSLR camera on the market. It is available to install on the tripod or other carrier to extend its shooting function.

It has a oversized touch screen on remote control, allows users to switch work modes, control rotating direction and set up parameters on it directly and visibly. Users can also control camera's follow focus and zooming after connecting camera to QING via cable.

Suggestion

Feiyu Qing includes below information, please read the information before using the gimbal:

1. Quick start guide
2. Online instruction
3. Tutorial

The tutorial videos can be watched at FeiyuTech official website <https://www.feiyu-tech.com/play/> or scan the QR code.

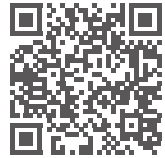

1. Overview

Gimbal

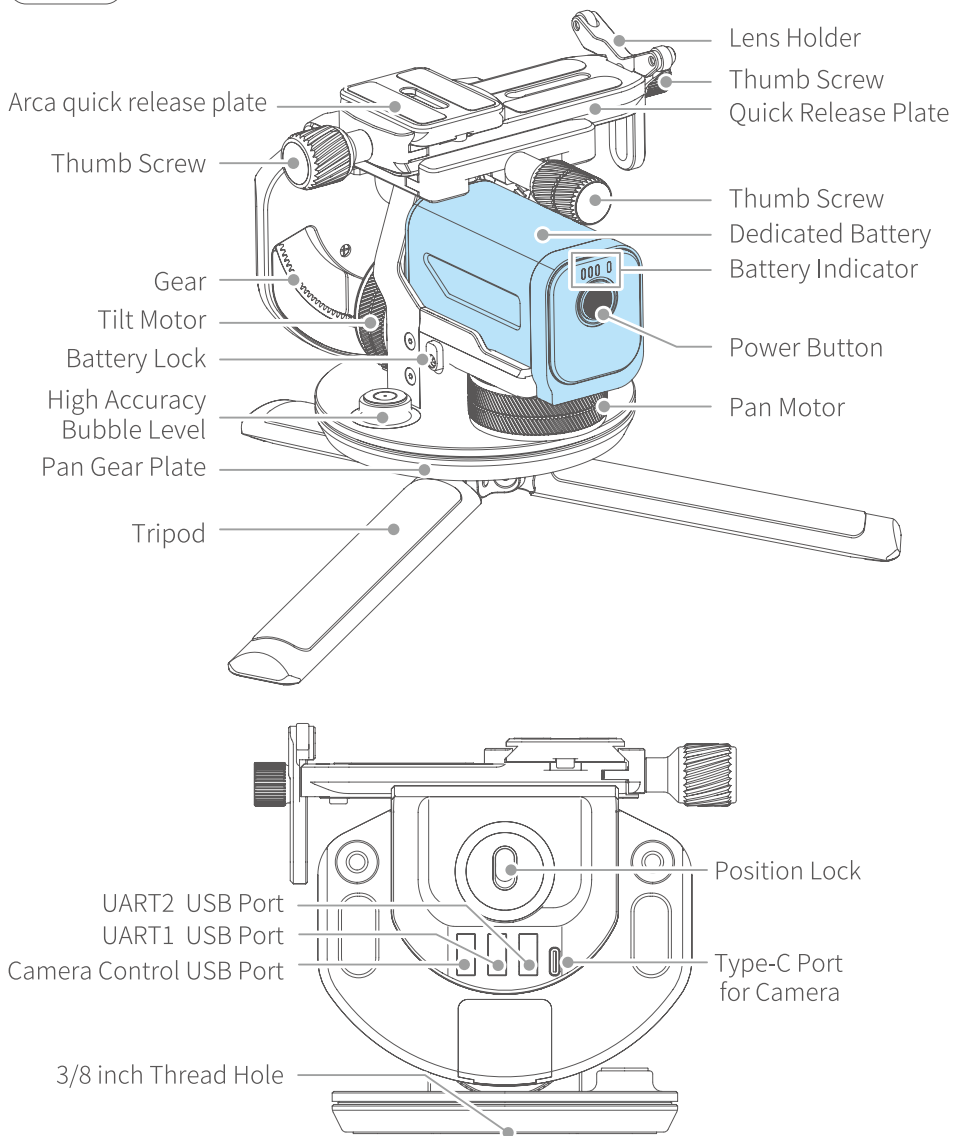

* The product is NOT included the camera.

Remote Control

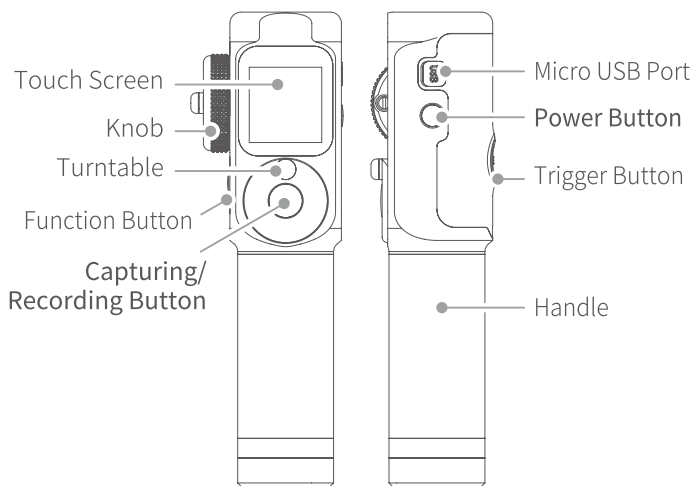

Capturing/Recording Button
 Single Tap: Take photo
 Long Press: Start/stop recording

Power Button
 Long Press: Power on/off
 Short Press in home page: Lock/unlock screen
 Short Press in other pages: Return to home page

Accessories



USB 2.0 to Micro
(A01) × 1



USB 3.0 to Micro 3.0
(A02) × 1



USB 2.0 to Mini
(B01) × 1



USB 2.0 to Type-C
(C01) × 1



Type-C to Multi
(Sony Shutter
Cable) × 1

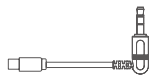

DC 2.5mm (Panasonic
Shutter Cable) × 1

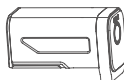

Dedicated Battery
× 1

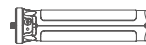

Tripod × 1

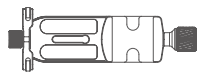

Quick Release Plate
× 1



Arca Quick Release
Plate × 1

2. Start to Use

TIPS

- Please install the camera and balance it before power on the gimbal.
- Please do not touch tilt motor and gears to avoid gripping.
- When the battery is low, please charge the battery.
- When not in use, power off the gimbal and then remove the batteries.

2.1 Charging

 Please fully charge the dedicated battery before power on the gimbal for the first time.

Please choose the suitable charger when quickly charging.

2.1.1 Charging for the Gimbal

Using USB 2.0 to Type-C cable to charge the dedicated battery, support 5V/3A input.

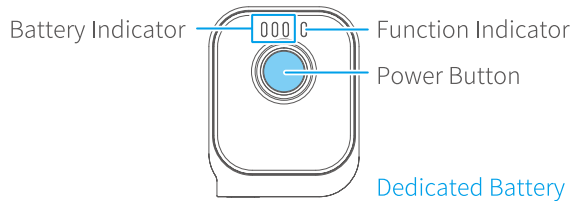
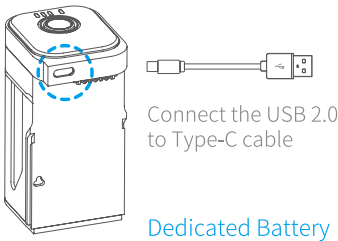

Battery Indicator: All the 3 indicators turn on when battery is full

Function Indicator:

quickly flashing: Low battery and please charge in time

slowly flashing: Pan mode

constant on: Lock mode

2.1.2 Charging for the Remote Control

Using USB 2.0 to Micro cable to charge the remote control, support 5V/3A input.

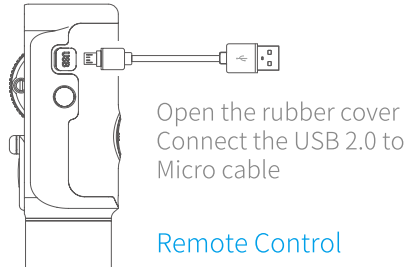

2.2 Unlock/Lock

There is a position lock on the tilt axis, which is convenient for locking the position, installation, storage.

 **Unlock the gimbal before powering on it.**

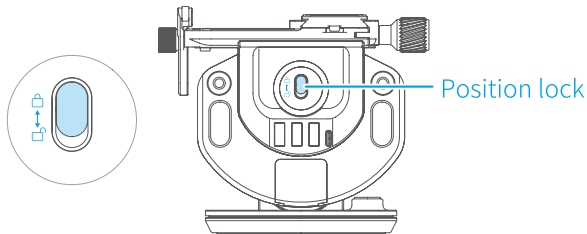

2.3 Battery Installation

 **Please fully charge the dedicated battery before power on the gimbal for the first time.**

Install the battery: Push the battery in along the slot ①, and after that, the battery lock ② will rebound to prevent battery from falling.

Remove the battery: Unlock the battery lock ② and pull the battery out.

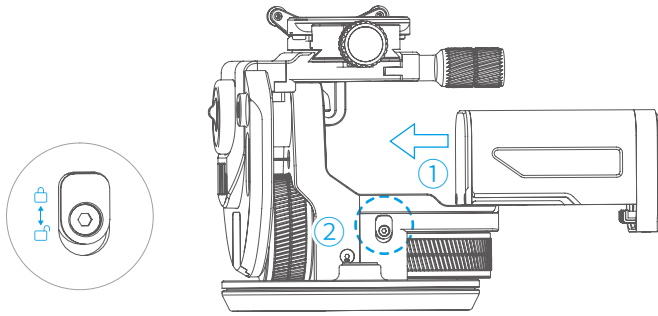

2.4 Camera Installation and Balance

TIPS

- Make sure the battery and memory card are loaded before camera installation.
- Before balancing the gimbal, the lens cover should be removed from the camera and the memory card needs to be inserted to the camera to complete all the cable connections to ensure that the camera is ready for shooting.
- During balancing the gimbal, make sure the camera is power off and the gimbal is turned off.
- If add accessories after the balance is completed, please re-balance.

In order to get ideal shooting, please balance the gimbal before using. And the gimbal with perfect balance will have longer battery life.

Step 1: Keep the gimbal horizontal as the figure shows, then lock the position lock ①.

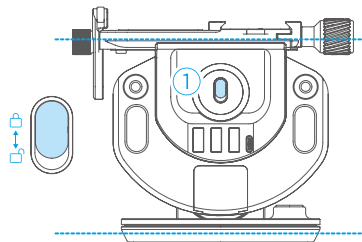

Step 2: Mount camera on ARCA quick release plate ②, and tighten it.

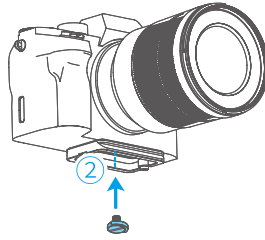

Step 3: Install the ARCA quick release plate on the quick release plate, and tighten the ARCA quick release plate safety lock ③. Install the lens holder ④ and tighten the thumb screw ⑤ to hold the lens firmly.

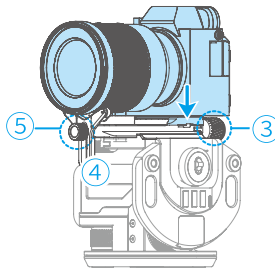

Step 4: Unlock the position lock ①, and loose the thumb screw ⑥. Slide the slide arm ⑦ to balance, and tighten the thumb screw ⑥ after the balancing is completed.

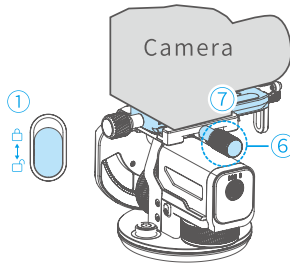

If the camera can stay stable after moving your hand away, which means balanced.

2.5 Power On/Off



Please release the tilt motor lock before powering on.
Please do not touch tilt motor and gears to avoid gripping.

Steps:

(1) Gimbal:

Install the dedicated battery and long press the power button of dedicated battery and release it when the battery indicator and function indicator turn on together and hear the tone. Long press again to power off.

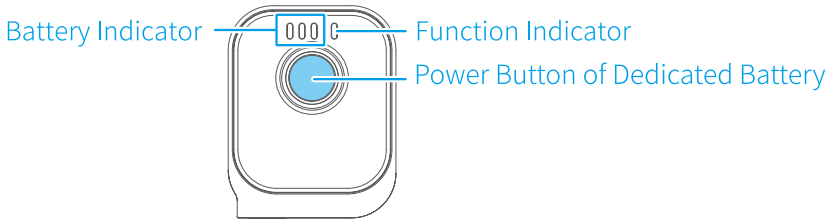

(2) Remote Control:

Long press the power button of remote control, release it when the touch screen shows **FJ**.

Long press again to power off.

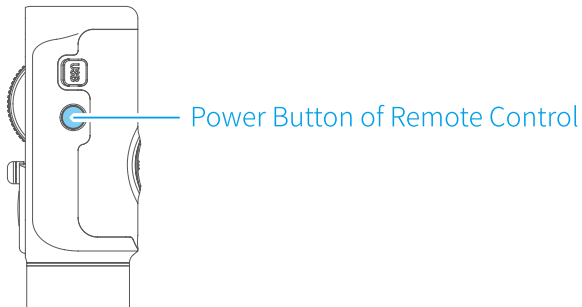

3. Function & Operation

3.1 Function/Modes Introduction

① Pan Mode (Default mode)

When attached on the other equipment, the tilt direction is fixed, and the camera direction moves according to the rotation of the equipment.

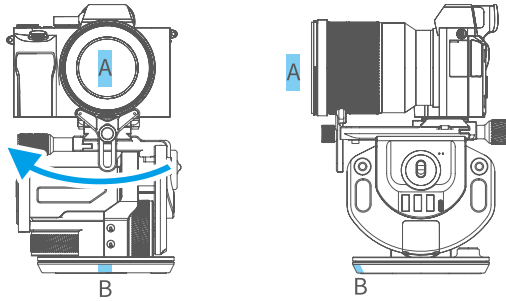

② Lock Mode

When attached on the other equipment, the tilt direction is fixed, the camera direction doesn't move while rotating the equipment.

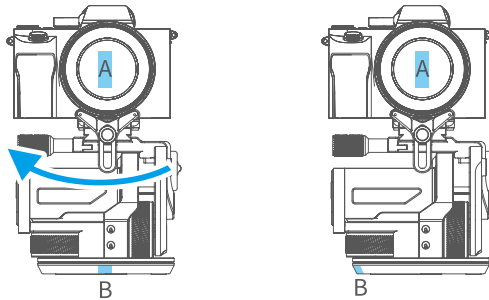

③ Reset

Reset to Pan mode, tilt and pan axis reset to initial position.

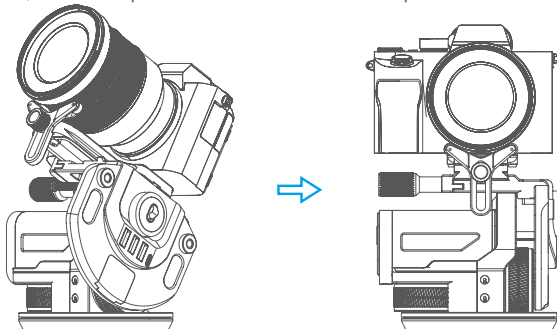

④ Time-lapse photography

User can set the start and stop shooting route on remote control, QING will auto rotate according the setting. [Refer to P17 3.4.1.](#) 

TIPS:

a. After click "Start" under time-lapse mode, gimbal will record all the movements before it stop. Do not repeat unnecessary actions during time-lapse.

b. The parameter a/b fps indicates how long the video will be play under the condition you set below. (Total duration and numbers of photos are automatically calculated by the gimbal without setting).

c. Please set the parameter for pan/tilt/interval/stop time. Interval time means the time that between two shooting. Stop time means the exposure time while taking photos.

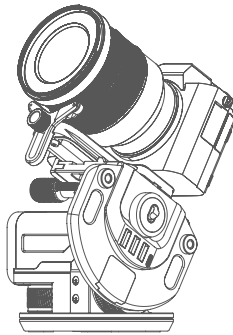



200s 24Fps
160s 30Fps 4801P
Pan 02:02:00
Tilt 04:00:00
Intv 00:00:03
Stop 00:00:01

⑤ Fast rotate

The rotating speed/interval time/stop time can be set. QING will rotate according to the setting parameter. No need to frequently manually set up during shooting.

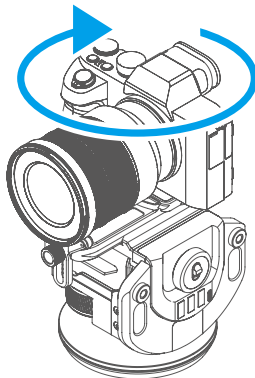
[Refer to P18 3.4.2.](#) 



	
Speed	12X
Interval	0S
Stop	0S

⑥ Wide Angle

For grand scenes or special scenes, the gimbal supports wide angle shooting (9 square panorama) can be assemble into 1 picture later on computer or Feiyu ON App. [Refer to P19 3.4.3.](#) 

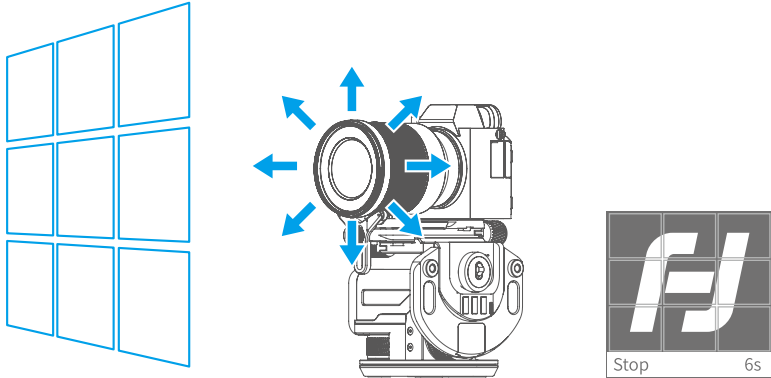

⑦ Pan Shoot

Gimbal will rotate precisely (pan rotate 180° or 360° for panorama) and take pictures according to the setting. [Refer to P19 3.4.4.](#) 

Take 180° for instance:

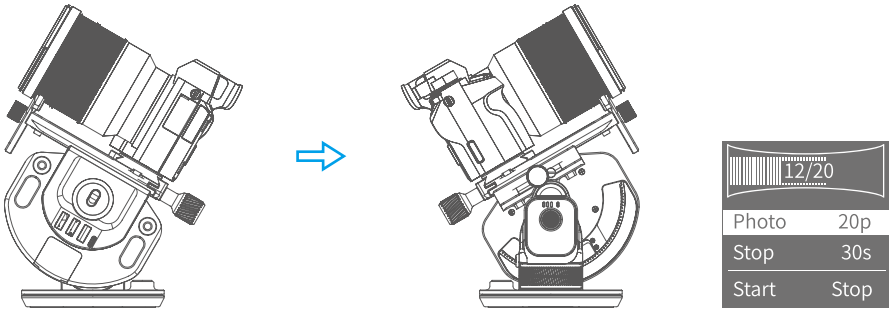

To get more videography skills with gimbal and it's tutorial, please kindly visit our official of Remote Control or download Feiyu ON App. <http://www.feiyu-tech.com>

3.2 Function Operation of Remote Control

3.2.1 Power Button of Remote Control Operation

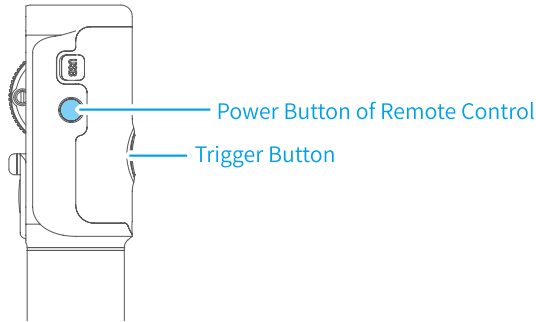

Button	Function	Instruction
Power Button of Remote Control	1. Power ON/OFF the remote	Long press (Long press the power button, and release it when it shows "FJ" on display.
	2. Lock/unlock screen	Short press in home page
	3. Return to home page	Short press in other pages

3.2.2 Trigger Button Operation

Button	Function	Instruction
Trigger Button	Reset	Double tap
	Exit current setting state, the knob and turntable can control pan and tilt axis instead of adjusting the parameter setting.	Single tap

3.2.3 Turntable Operation

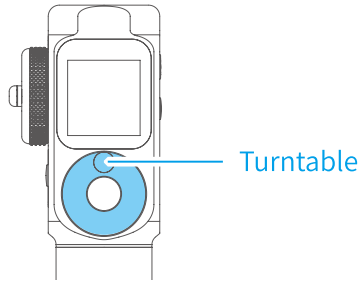

Button	Function	Instruction
Turntable	1. Control the movements on pan axis	Rotate the turntable
	2. Adjust the parameter	Rotate the turntable

3.2.4 Capturing/Recording Button Operation

After QING connecting control cable with camera, Remote Control can directly control picture-taking, video recording, follow focus.

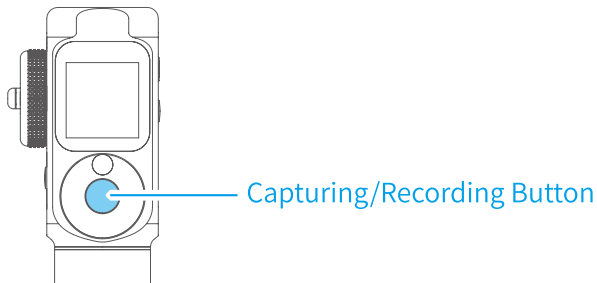

Button	Function	Instruction
Capturing/Recording button(2-stage way, half-way press and fully press)	1. Focus	(Half-way press condition)Single tap
	2. Photo shooting	(Fully press condition) Single tap
	3. Video recording	Long press for 3 seconds

3.2.5 Knob Operation

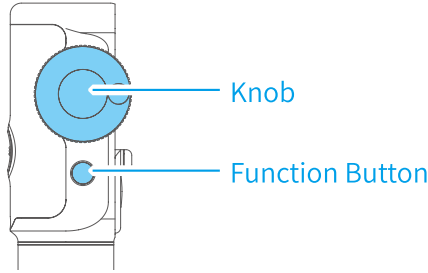

Button	Function	Instruction
Knob	1. Control the movements on tilt axis	Rotate clockwise or anti-clockwise
	2. Select the setting	Rotate clockwise or anti-clockwise

3.2.6 Function Button Operation

Button	Function	Instruction
Function Button	Switch sensitivity: fast/low	Single tap
	Switch control object: tilt axis/optional object*	Double tap

*select electronic follow focus, electronic zoom, AKF II in control object setting in the second screen. After selecting, it can be switched to control in home page.

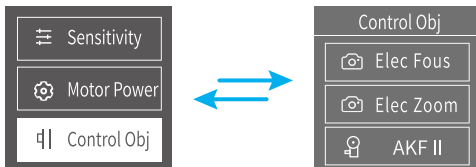

3.2.7 Power Button of Dedicated Battery Operation

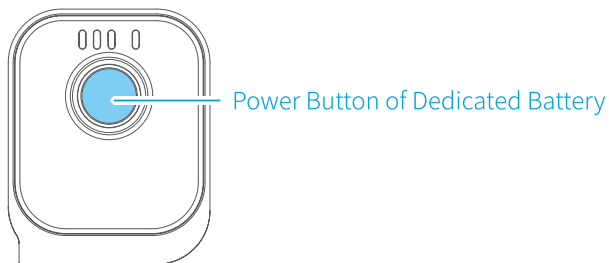

Button	Function	Instruction
Power Button of Dedicated Battery	Power on/off	Long press and release
	Customize initial position*	Double tap

NOTE :

The battery should be installed before using.

The default angle for tilt and pan axis is 0° , user can customize the initial position by rotate the turntable and knob. (To reset to default angle please rotate the turntable and knob to the position the image shows below and double tap the power button dedicated battery).

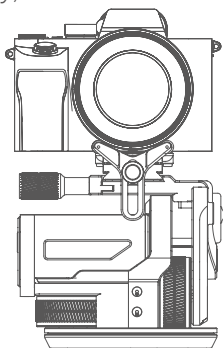

3.3 Remote Control Touch Screen

3.3.1 Touch Screen

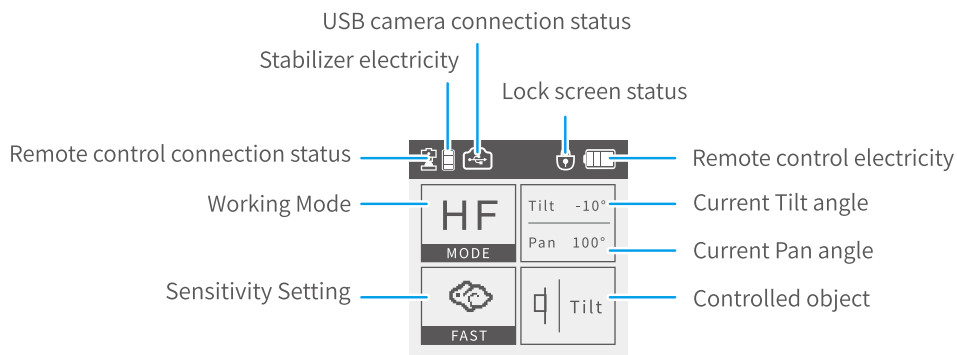

Display icon	Mode / Status	Display icon	Mode / Status
	Gimbal Connected	MODE	Current Mode
	Gimbal Disconnected	HF	Pan Mode
	Battery Level of Remote Control	LK	Lock Mode
	USB Camera Connected	Tilt	Tilt Axis
	USB Camera Disconnected	Pan	Pan Axis
	Lock Status		High Sensitivity
	Unlocked Status		Low Sensitivity
	Battery Level		Control-Brushless Follow Focus
	Control-Follow Focus		Control-Gimbal Tilt Axis
	Control-Zoom In/Out		

3.3.2 Display Screen Switching

Switch screen by sliding left and right.

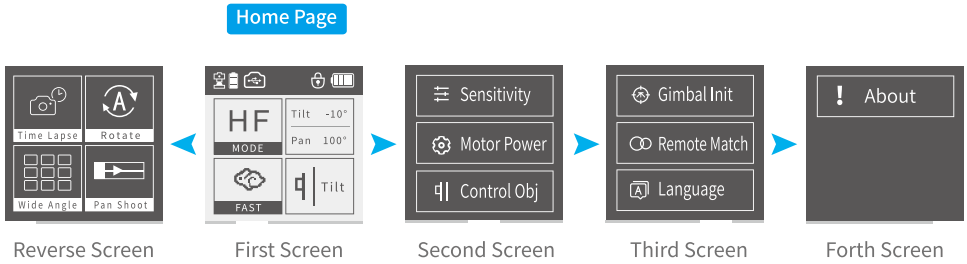

3.3.3 Touch Screen Common Gesture Operation

Slide to left: Switch to left screen

Slide to right: Switch to right screen/back to previous page

Click: Check this option

3.3.4 Lock and Unlock

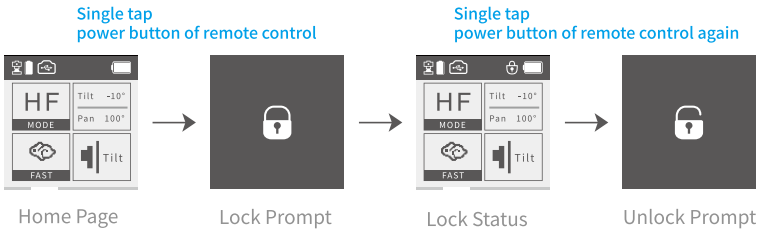

3.4 Modes Setting

- ← Slide right to left
- Slide left to right
- Tap to select current menu

3.4.1 Time-lapse Photography Mode

(1) Slide to right to enter reverse screen, click to enter the time-lapse photography interface, the interface has three options (time setting, path setting, last configuration).

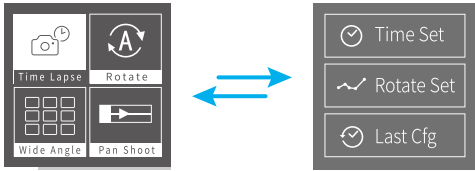

(2) For the first time, please set up all the time parameters at Time Set menu, including movements time on pan, tilt axis, interval time and stop time for long exposure of photography.

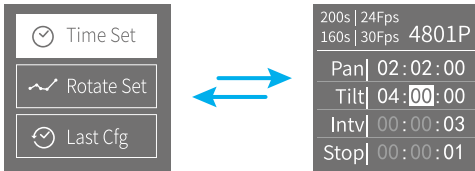

(3) Enter Rotate Set menu, use the knob and the turntable to control the path of lens, record start and end points of path.



(4) Click Start to go to auto timelapse photography, the gimbal will show up remaining time, current and total number of photos. Please wait for completion by itself.

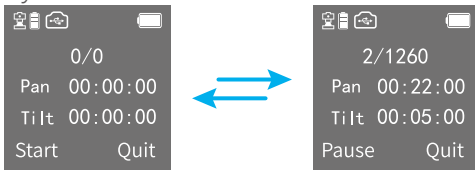



3.4.2 Fast Rotation Mode

(1) Slide to right to enter reverse screen, tag to enter the automatic rotation mode.

(2) Adjust by the turntable:

- ① select the gear position of speed (There are 30 gears from 1 to 30, the gear position is indicated by "X", the higher the gear speed is, the faster the speed)
- ② Set interval time/stop time (How often to take a photo and how long to exposure for each photo).

(3) Tag direction icon  or , to start to rotate, tag again to stop. Once got settings set up, simply tag the trigger button to re-control the pan/tilt via turntable and knob.

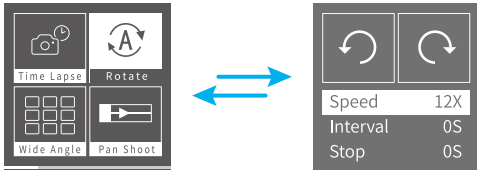

3.4.3 Wide Angle

Slide to right to enter reverse screen, tag to enter the Wide Angle interface, as the picture shows:

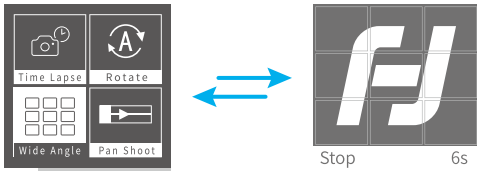

Once setting done, simply tag the trigger button to re-control the pan/tilt via turntable and knob.

3.4.4 Pan Shoot

Slide to right to enter reverse screen, tag to enter the pan shoot interface, and have 180° panorama and 360° panorama. Tag to enter, set the number of photos and seconds to stay, tag "Start". As the picture shows:



Once setting done, simply tag the trigger button to re-control the pan/tilt via turntable and knob.

3.4.5 Sensitivity Setting

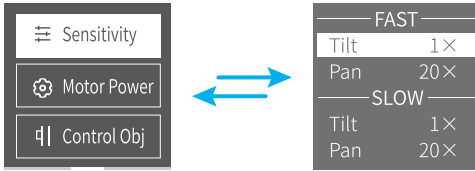

Once setting done, simply tag the trigger button to re-control the pan/tilt via turntable and knob.

3.4.6 Control Object Setting

Use the touch screen to switch.

[Refer to P15 3.2.6.](#) 

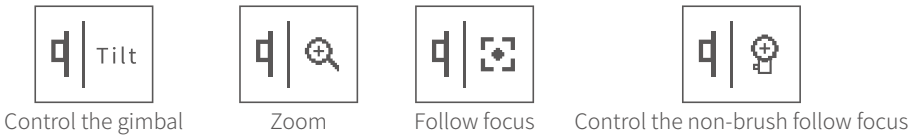

3.4.7 Motor Power Setting

Scroll the left knob to select auto/customize, and scroll the turntable under the display to adjust the custom force.

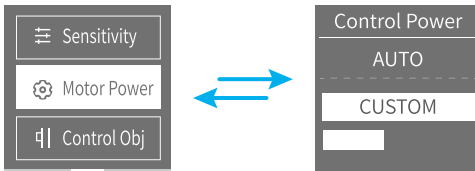

After setting, just click the trigger button to make the knob and turntable control the gimbal again.

3.4.8 Gimbal Calibration Setting

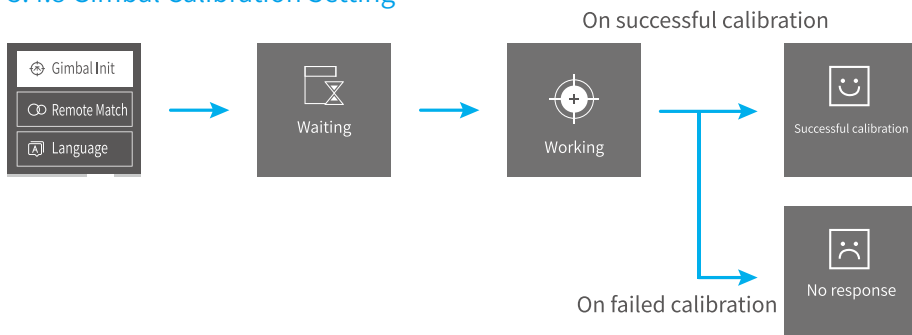

3.4.9 Remote Matching Settings

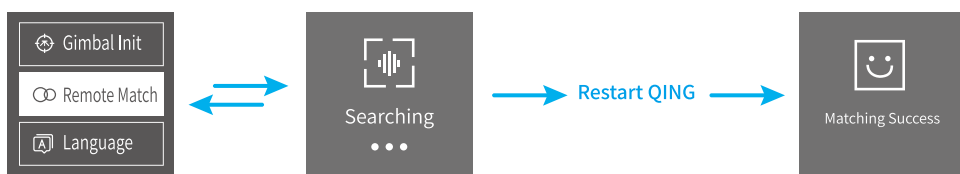

3.4.10 Language Settings

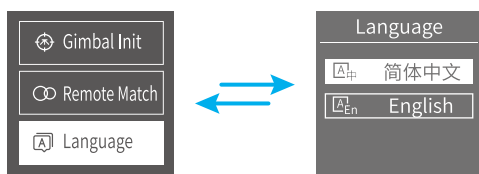

3.4.11 About the Gimbal

Introduction about the firmware version of the device.

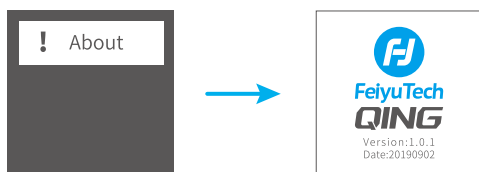

3.5 Gimbal Initialization

You can initialize your gimbal when:

- When camera is not level.
- If not use for a long period of time.
- In case of extreme temperature variations.

Gimbal calibration step:

- (1) put the gimbal on the horizontal table.
- (2) Select "gimbal calibration" on the remote control ([Refer to P21 3.4.8](#) ).
- (3) During the calibration, the tilt will sag gently.
- (3) After the calibration is successful, the gimbal will be gently raised to the horizontal state.

4. Accessories

4.1 Brushless Follow Focus (AKF II)

- ① Fix the lens gear to the camera's focus ring position.
- ② Fasten the fixed bracket to the quick release plate of the gimbal with a hexagonal screw, and insert the aluminum tube (if the lens holder is attached to the gimbal, remove it).
- ③ Insert the follower into the aluminum tube, move the aluminum tube to adjust the front and rear position so as to make the follower gear and the lens gear engage, and lock the fixed thumb screw on the fixed bracket.
- ④ Connect the USB cable to the USB port as the picture shown, the installation is completed.

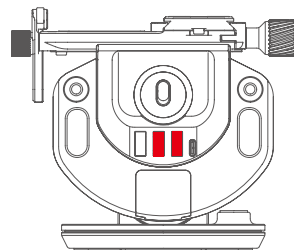
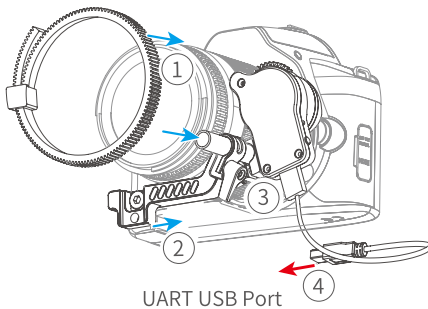

UART1 USB Port
or
UART2 USB Port

For more instructions, please check AKF2 AK series brushless follow focus manual.

4.2 Wireless MIC Kit

The receiver transmitter can collect the sound from the transmitter within 20m range.

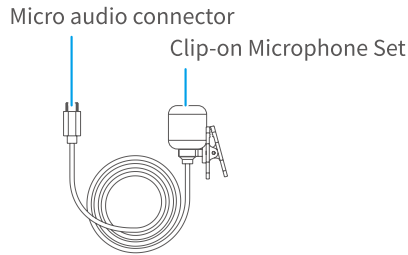
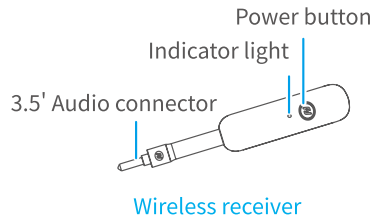
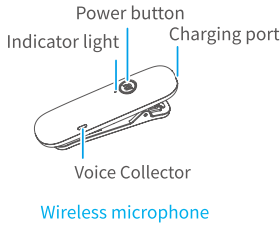

4.2.1 How to Use

- (1) Manually set video mode on camera.
- (2) Plug in the wireless microphone (receiver terminal) to camera MIC jack. Turn it on.

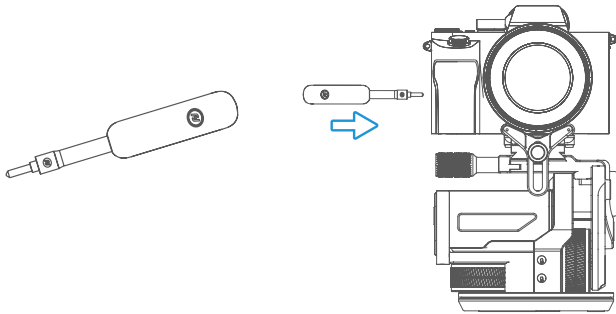

- (3) Turn on the wireless microphone (transmitter terminal), it is available to use. (To get a better effectiveness, please wear it as close to the sound source as possible.)

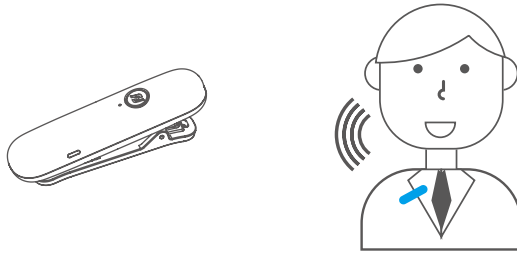

(4) Plug the wireless clip-on microphone in the wireless microphone (transmitter terminal) mount.

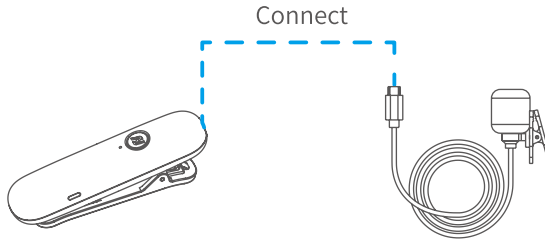

4.2.2 Wireless microphone kit is available to use individually.

4.2.3 The indicator description of wireless microphone kit
 * Workable for both receiver and transmitter terminal.

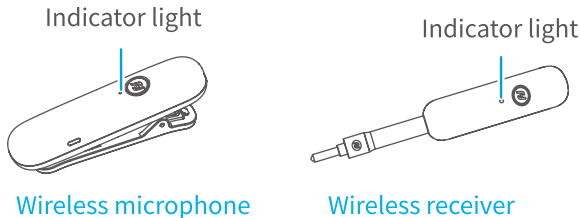

Status	Indicator	ICON
Power ON	Blue light stays on to flashes regularly	
Power OFF	Red light stays on to off	
Low battery	Red light flashes regularly	
Fully charged	Green light stays on	
Connected	Blue light flashes regularly	

5. Specifications

Product Dimensions	134mm × 157mm × 133mm
Max. Tilting Range	120°
Max. Panning Range	360°
Tilting Speed	8°/s ~ 140°/s
Panning Speed	12°/s ~ 165°/s
Theoretical Battery Life for Gimbal	5.5h
Weight	Gimbal 1340g (Including Battery) Remote Control 316g (Including Battery)
Payload Adapted cameras	3500g (After Balancing)

Compatible Cameras for Reference

QING Lens Compatible List						
Brand		Can be equipped with a lens				
Brand	Camera(H/W/D)	Model	Lens size & weight (Φ×L)	Camera	Brushless follow focus + Camera	Remark
Sony	Sony A7R3 126.9×95.6×62.7mm 572g Sony A7M3 126.9×95.6×73.7mm 565g Sony A9 126.9×95.6×63mm 588g Sony A7S2 126.9×95.7×60.3mm 584g Sony A7R2 126.9×95.7×60.3mm 582g Sony A7M2 126.9×95.7×59.7mm 556g	E 10–18mm F4 OSS	Φ70mm×63.5mm 225g	✓	✓	
		FE 12-24mm F4 G	Φ87mm×117mm 565g	✓	✓	
		FE 16-35mm F2.8 GM	Φ89mm×122mm 680g	✓	✓	
		FE16-35mm f/4 ZA OSS	Φ78mm×99mm 518g	✓	×	
		Vario-Tessar FE 24-70mm F4 ZA OSS	Φ73mm×94.5mm 426g	✓	✓	
		FE 24-70 F2.8 GM	Φ87.6mm×136mm 886g	✓	×	
		Zeiss E 16-70 F4 OSS	Φ66.6mm×75mm 308g	✓	✓	
		E PZ 18–105mm F4 G OSS	Φ78mm×110mm 427g	✓	✓	
		E PZ 18–200mm F3.5–6.3 OSS LE (SEL18200LE)	Φ68mm×97.1mm 460g	✓	×	
		FE 28mm F2	Φ64mm×60mm 200g	✓	✓	
		Zeiss FE 35mm F2.8 ZA	Φ61.5mm×36.5mm 120g	✓	✓	
		Sigma 30mm f/1.4 DC DN	Φ64.8mm×73.3mm 265g	✓	✓	
		Sigma 35mm f1.4 DG HSM Art	Φ77mm×94mm 665g	✓	✓	
		FE 55mm F1.8	Φ64mm×71mm 281g	✓	✓	
		FE 50mm F2.8 MACRO	Φ71mm×71mm 236g	✓	✓	
		FE 4/24-105 G OSS	Φ83.4mm×113.3 mm 663g	✓	✓	
		FE 28-70mm f/3.5-5.6 OSS	Φ72.5mm×83mm 295g	✓	✓	
		FE 85mm F1.4 GM	Φ89.5mm×107.5mm 820g	✓	✓	
	Sony A6400 120×67×60mm 359g Sony A6300 120×66.9×48.8mm 361g Sony A6500 120×66.9×53.3mm 410g	E 10–18mm F4 OSS	Φ70mm×63.5mm 225g	✓	✓	
		FE 12-24mm F4 G	Φ87mm×117mm 565g	✓	✓	
		FE 16-35mm F2.8 GM	Φ89mm×122mm 680g	✓	✓	
		FE16-35mm f/4 ZA OSS	Φ78mm×99mm 518g	✓	✓	
		Vario-Tessar FE 24-70mm F4 ZA OSS	Φ73mm×94.5mm 426g	✓	✓	
		FE 24-70 F2.8 GM	Φ87.6mm×136mm 886g	✓	✓	
		Zeiss E 16-70 F4 OSS	Φ66.6mm×75mm 308g	✓	✓	
		E PZ 18–105mm F4 G OSS	Φ78mm×110mm 427g	✓	✓	
		E PZ 18–200mm F3.5–6.3 OSS LE (SEL18200LE)	Φ68mm×97.1mm 460g	✓	✓	
		FE 28mm F2	Φ64mm×60mm 200g	✓	✓	
		Zeiss FE 35mm F2.8 ZA	Φ61.5mm×36.5mm 120g	✓	✓	
		Sigma 30mm f/1.4 DC DN	Φ64.8mm×73.3mm 265g	✓	✓	
		Sigma 35mm f1.4 DG HSM Art	Φ77mm×94mm 665g	✓	✓	
		FE 55mm F1.8	Φ64mm×71mm 281g	✓	✓	
		FE 50mm F2.8 MACRO	Φ71mm×71mm 236g	✓	✓	
		FE 4/24-105 G OSS	Φ83.4mm×113.3 mm 663g	✓	✓	
Panasonic	GH5S 138.5×98.1×87.4mm 660g GH5 138.5×98.1×87.4mm 725g GX9 136.9×97.3×91.6mm 658g GH4 93.4×83.9×132.9mm 560g	Panasonic 24-105mm F4 L	680g	✓	✓	
		Panasonic 50mm F1.4 L-Mount S-X50GK	Φ90mm×130mm 955g	✓	✓	
		LEICA DG Vario-Elmarit 12-60 f/2.8-4 Power OIS	Φ68mm×86mm 320g	✓	✓	
		Panasonic 24-70mm F2.8 L-Mount S-E2470GK	Φ90.9mm×140mm 935g	✓	✓	
		Panasonic 70-200mm F4	Φ83mm×179mm 985g	✓	✓	
		Lumix 35-100mm F2.8 II	Φ67mm×99mm 357g	✓	×	
		LUMIX G 14-140mm f/4-5.8 OIS	Φ70mm×84mm 460g	✓	✓	
		AF-S 24-120mm f/4G ED VR	710g	✓	✓	
Nikon	Z6 775g Z7 775g D7500 720g	18-140mm f/3.5-5.6G ED VR	Φ78mm×97mm 490g	✓	✓	
		NIKKOR Z 50mm f/1.8 S	415g	✓	✓	
		NIKKOR Z 24-70mm f/4 S	500g	✓	✓	
		NIKKOR 70-300mm f/4.5-6.3G ED VR	415g	✓	✓	
		NIKKOR 70-200mm f/2.8E FL ED VR	1.43KG	✓	✓	

QING Lens Compatible List						
Brand		Can be equipped with a lens				
Brand	Camera(H/W/D)	Model	Lens size & weight (Φ×L)	Camera	Brushless follow focus + Camera	Remark
佳能	EOS R EOS RP	EF-S 18-200mm f/3.5-5.6 IS	Φ78.6mm×102mm 595g	√	√	
		EF 24-70mm f/4L IS USM	Φ83.4mm×93mm 600g	√	√	
		EF 50mm f/1.4 DG HSM Art	Φ85mm×100mm 815g	√	√	
		RF 28-70mm F2L USM	Φ103.8mm×139.8mm 1430g	√	√	
		RF 24-105mm F4L IS USM	Φ83.5mm×107.3mm 670g	√	√	
佳能	5D MarkIV 5D MarkIII 6D MarkII 6D 80D EOSR	EF 70-200mm f/2.8L IS III USM	1.48KG	√	×	
		EF 70-300mm f/4-5.6 IS II USM	1.05KG	√	×	
		EF-S 18-200mm f/3.5-5.6 IS	595g	√	√	
		EF 24-70mm f/4L IS USM	600g	√	√	
		EF 24-70mm f/2.8L IS USM	805g	√	√	
		EF 24-105mm f/3.5-5.6L IS USM	525g	√	√	
		EF 24-105mm f/4L IS USM	795KG	√	√	
		EF 16-35mm f/2.8L IS USM	1.1KG	√	√	
		EF 200mm f/2.8L II USM	1.1KG	√	×	

Tips: The camera needs to be close to the tilt motor.

Disclaimer

Thanks for using FeiyuTech product. The information in this document affects your safety and your legal rights and responsibilities. Read the entire document carefully to ensure proper configuration before use, Failure to read and follow instructions and warnings in this document may result in serious injury to yourself or others, or damage to your products or damage to other objects in the vicinity.

By using this product, you hereby signify that you have read this disclaimer and warning carefully and that you understand and agree to abide by the terms and conditions herein. You agree that you are solely responsible for your own conduct while using this product, and for any consequences thereof. You agree to use this product only for purposes that are proper and in accordance with all applicable laws, rules, and regulations, and all terms, precautions, practices, policies and guideline FeiyuTech has made and may make available. FeiyuTech accepts no liability for damage, injury or any legal responsibility incurred directly or indirectly from the use of product.

FeiyuTech will not provide any service for any product obtained from abnormal channels.

Notice

1. Make sure motor spinning is not blocked by external force when the product is power on.
2. DO NOT contact the product with water or other liquid if the product is not mark waterproof or splash-proof. Waterproof and splash-proof product. DO NOT contact sea water or other corrosive liquid.
3. DO NOT disassemble the product except is detachable available. It need send to FeiyuTech after-sales or authorized service center to fix it if you accidentally disassemble it and cause abnormal work. The relevant costs are borne by user.
4. Prolonged continuous operation may cause the product surface temperature to rise, please operate carefully.

Storage and Maintenance

1. Keep the product or removable batteries or accessories out of the reach of children and pets.
 2. DO NOT leave the product or removable batteries or accessories near heat sources such as a furnace or heater.
- DO NOT leave the product or removable batteries or accessories inside of a vehicle on hot days.

3. Please storage the battery in dry environment.
4. DO NOT overcharge or overuse the battery, otherwise it will cause damage to the battery core.
5. Never use the product when the temperature is too high or too low.
6. For the product with removable batteries, please take out batteries if you don't use it for a long time.

Battery Safety Guidelines

1. To avoid fire, serious injury, and property damage, observe the following safety guidelines when using, charging or storing the battery.

(1)DO NOT allow the battery to come into contact with any kind of liquid. DO NOT leave the battery out in the rain or near a source of moisture. DO NOT drop the battery into water.

(2)If the battery falls into water by accident, put it in a safe and open area immediately. Maintain a safe distance from the battery from the battery until it is completely dry. Never use the battery again.

(3)If batteries catch fire, use water, water mister, sand, fire blanket, dry powder, carbon dioxide fire extinguisher to extinguish the fire immediately. It is prone to explosion after a large fire. Please choose the fire extinguishing method according to above recommended order according to the actual situation.

(4)DO NOT use or charge swollen, leaky or damage battery.

(5)DO NOT disassemble or pierce the batteries in any way or the battery may leak.

(6)DO NOT drop or strike batteries. DO NOT place heavy objects on the battery or charger.

(7)DO NOT use the battery if it falls.

(8)DO NOT heat batteries.

(9)DO NOT use the batteries in strong electrostatic or electromagnetic environments. Otherwise, the battery may occur short circuit.

(10)Electrolytes in the battery are highly corrosive. If any electrolytes make contact with your skin or eyes, immediately wash the affected area with fresh running water for at least 15 minutes, and then see a doctor immediately.

(11)Please use official batteries are provided by FeiyuTech. If you need replace the battery, please purchase at FeiyuTech official website or authorized dealer. FeiyuTech will not be responsible for the battery accident and devices malfunction cause by batteries use from unofficial provided.

2. DO NOT drop or strike batteries. If the battery is abnormal, contact Feiyu After-sales support.

Official Social Media



Website



Facebook



Youtube



Twitter



Instagram

Facebook: www.facebook.com/feiyutech

YouTube Channel: www.youtube.com/c/Feiyu-tech

Twitter: www.twitter.com/feiyutech

Instagram: www.instagram.com/FeiyuTech

YouTube Channel: www.youtube.com/c/Feiyu-tech

Online Store: store.feiyu-tech.com



Guilin Feiyu Technology Incorporated Company

For more information, please visit our official website www.feiyu-tech.com

E-mail: service@feiyu-tech.com Tel: +86 773 2320865

Due to software and hardware improvements, your actual product might differ from the descriptions and pictures in this user manual. You can get the latest user manual from the official website.